

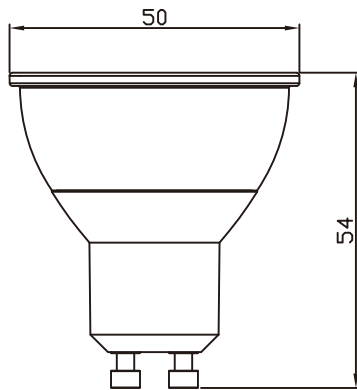

## Diamond lens GU10 7W Ra>80

### FEATURES

- Replacement for 75W incandescent lamps
- Suitable for dry and damp locations
- Dimmable down to 5%
- Flicker less than 33%
- Work with most of existing dimmer in market
- Contact us to get the dimmer list
- Three years limited warranty



## GENERAL SPECIFICATIONS

Form Factor	Operating Temperature	Electrical	Dimming and flicker
Width:50mm(1.97")	Minimum: -25°C(ambient)	Wattage: 7W	Dimmable to: <5%
Height:54mm(2.13")	Typical: 68°C-77°C (housing)	Power factor: >0.9	Flicker Index: 0.09682
Weight: 66g	Maximum:40°C (ambient)	Voltage: 120V	Percent Flicker:32.95%
		Frequency: 60Hz	

## SPECIFICATIONS BY MODEL NO.

Model#	SKU#	CCT(K)	Ra	Lumen	Efficacy	B.A.	CD	Dim	Lifetime	Replac
GU10NCOB7WDIM8040W27K	8005812	2700	>80	593lm	85	40°	1241	YES	25000H	75W
GU10NCOB7WDIM8040W30K	8004808	3000	>80	564lm	83	40°	1250	YES	25000H	75W
GU10NCOB7WDIM8040W40K	8007670	4000	>80	611lm	91	40°	1256	YES	25000H	75W
GU10NCOB7WDIM8040W50K	8004815	5000	>80	619lm	84	40°	1282	YES	25000H	75W

# PHOTOMETRIC INFORMATION

## ZONAL LUMEN SUMMARY

Zone	Lumens	% lum, lamp
0-30	473.4	76.3
0-40	518.9	83.7
0-60	571.1	92.1
0-90	602.4	97.1

## LUMINOUS DISTRIBUTION INTENSITY DIAGRAM

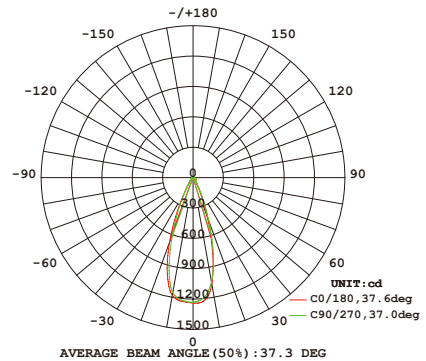

## LUMINOUS DISTRIBUTION INTENSITY DATA

C (DEG) \ γ (DEG)	0	23	45	68	90
0	1189	1187	1185	1182	1179
5	1141	1138	1139	1138	1142
10	973	970	977	987	1011
15	703	694	708	722	762
20	406	397	413	433	471
25	197	193	203	216	246
30	99.0	94.6	99.0	105	119
35	55.3	54.1	54.4	57.5	64.3
40	39.9	39.0	38.8	40.3	42.8
45	33.6	32.8	31.9	32.7	33.9
50	33.4	32.3	30.5	28.8	28.7
55	27.6	27.0	26.5	25.2	25.7
60	20.3	20.3	19.7	19.8	20.7
65	16.1	15.9	15.9	16.0	16.6
70	12.0	12.3	12.6	12.8	13.4
75	7.53	7.64	8.02	8.33	9.12
80	4.63	4.60	4.77	4.91	5.55
85	2.18	2.13	2.24	2.36	2.80
90	1.61	1.57	1.55	1.52	1.54

## ILLUMINANCE AT DISTANCE

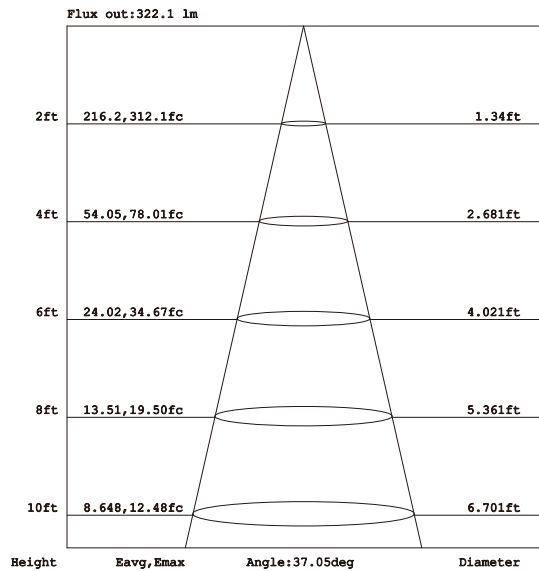

# PHOTOMETRIC INFORMATION

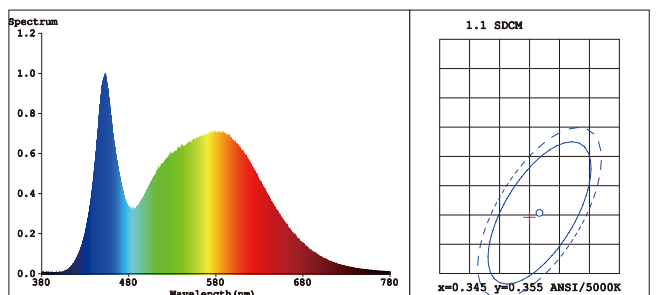
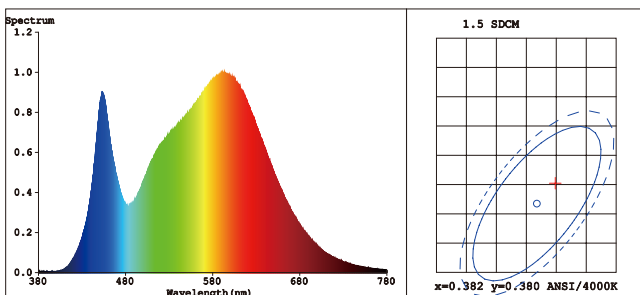
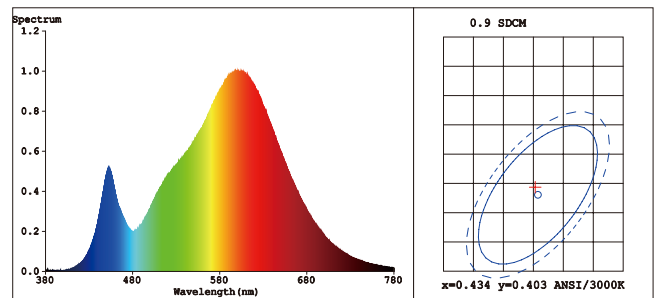
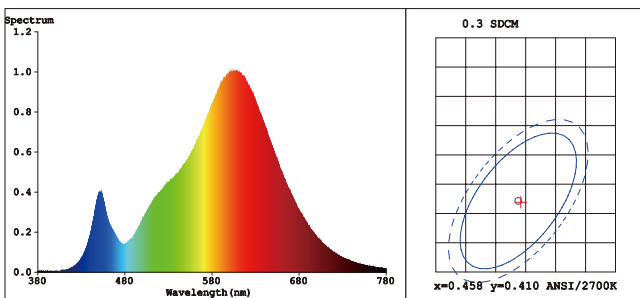

A & L Electric Sales  
 8028 N.W. 68th Street  
 Miami, Florida 33166

Phone: (305)591-8448